

MORI-SAY

TMZ867CNC

EIGHT-SPINDLE AUTOMATIC LATHE



TAJMAC - ZPS



OVERVIEW

- 02 | 03 Manufacturer | Parts
- 04 | 05 Machine | Introduction
- 06 | 07 Advantages | Technical data



Shaping of steel has always been our craft.
We have managed to improve the craft further.

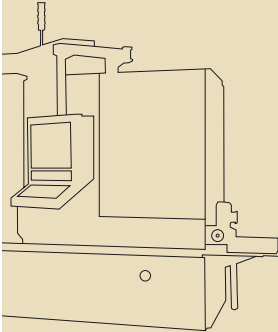

TAJMAC

The TAJMAC group currently belongs to leaders in the field of machine tools manufacturing in Europe. MORI-SAY multi-spindle automatic equipment offers an extraordinary concept of machinery for economic manufacturing of parts in large batches. Complete know-how from engineering up to machinery construction and adjustment coming from a single point.

The outcome of this experience and continuous innovation is represented by the TMZ machinery series. Besides MORI-SAY TMZ642CNC, the MORI-SAY TMZ867CNC represents and sign board among multi-spindle automatic equipment. Productivity, stability and flexibility make this eight-spindle automatic CNC one of the very interesting options on the market for multi-spindle automatic equipment, as far as the price-performance ratio is concerned.



44SMn28 | Ø 45 mm | length 75 mm



CuZn31Si1 | Ø 59 mm | length 46 mm

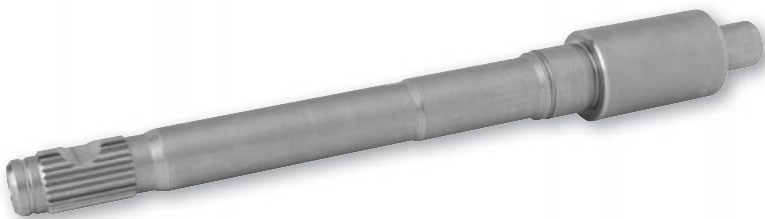

18NiCrMo5 | Ø 23 mm | length 190 mm



20MnCr5 | Ø 50 mm | length 1200 mm

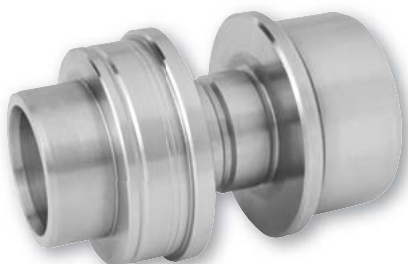

C45 | Ø 56 mm | length 85 mm



42CrMo54 | Ø 32 mm | length 55 mm

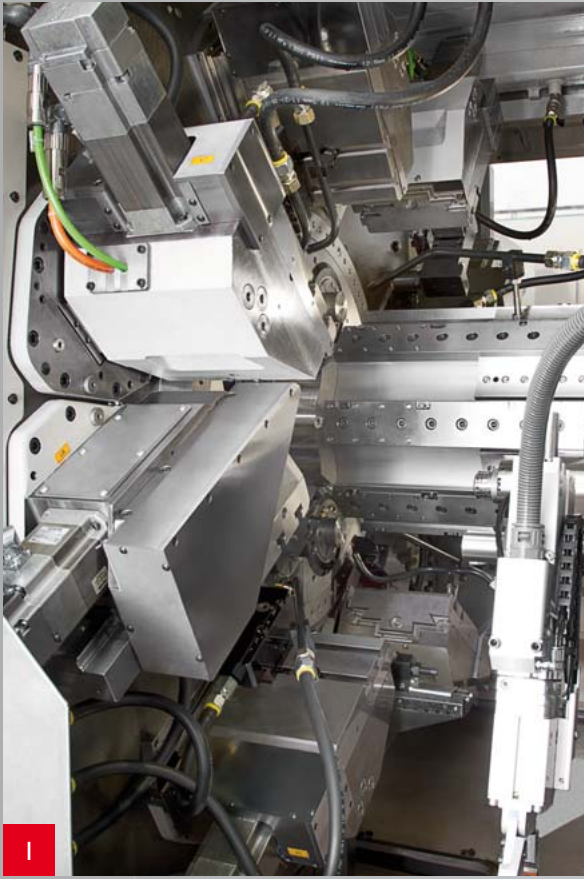

WORK SPACE



CNC CONTROL

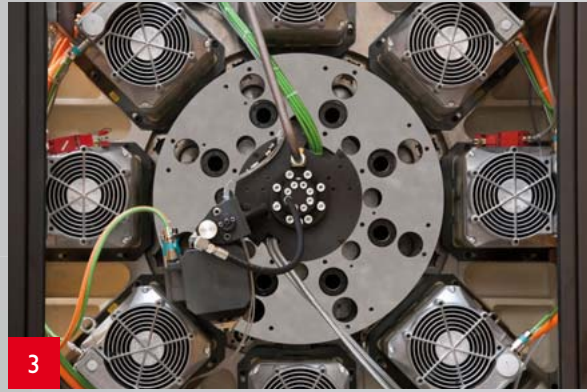

SPINDLE DRIVE



MORI-SAY

TMZ867CNC

- 1** Machine work space enables sufficient access for adjustment and ensures good removal of chips as well as their transport from the machine work space.
- 2** Two systems Siemens 840D ensure reliable control of 32 main and 24 auxiliary axes.
- 3** Eight independent AC drives for main spindles with output of 7 kW per spindle enable reliable machining even on materials hard to machine.



The eight-spindle automatic lathe MORI-SAY TMZ867CNC enables automatic machining of rotary bar parts with high productivity, as well as machining of intermediates, (mouldings, castings,...).

The machine combines advantages of high productivity provided by conventional, cam controlled multiple-spindle automatic equipment with complex CNC hardware.

ADVANTAGES

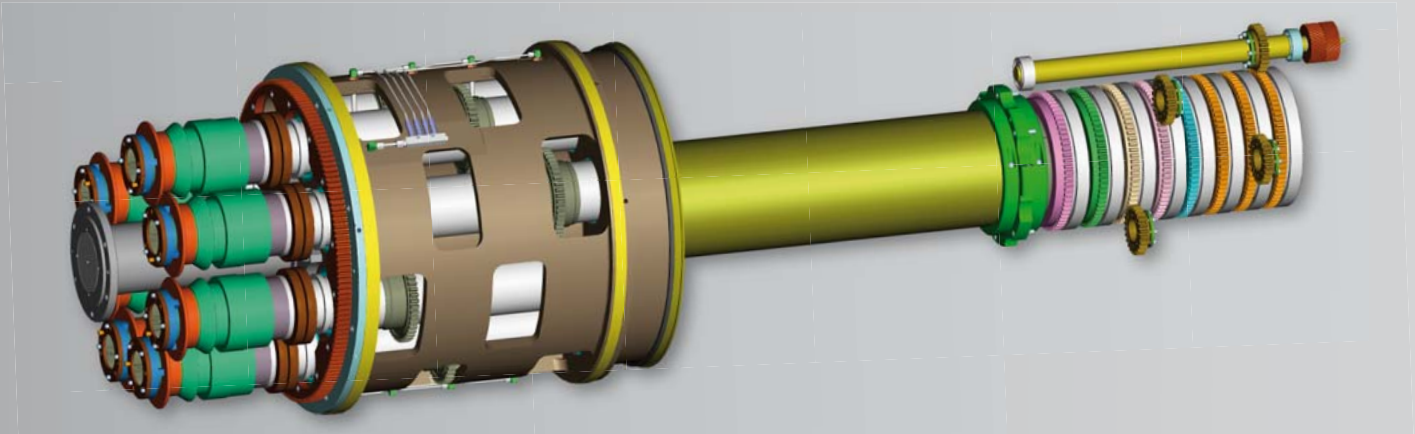

COAXIAL DRIVE

The coaxial drive of MORI-SAY TMZ867CNC offers the following advantages: Drive motors are provided with fixed and static attachments, which means these are not linked to the spindle drum. The concept enables high transfer of output from individual motors and minimum heating of the spindle drum. This purely mechanical link between the motor and spindle (contactless / brushless), enables continuous rotation of the spindle drum.

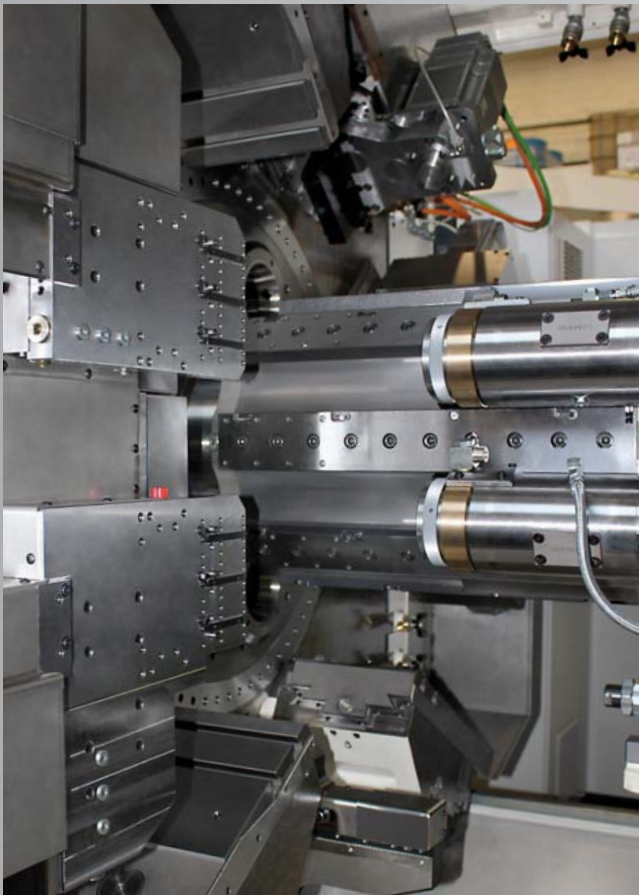

DOUBLE TAKER

Auxiliary axes enable installation of two part takers. The relevant CNC cross saddles then enable complex machining on pick-up side. Optional solution comprises application of traverse machining driven tools.



Y- SADDLE

The machine MORI-SAY TMZ867CNC can be used with up to five auxiliary cross saddles with Y-axis. These saddles can be mounted with up to three tool holders. Optional solution comprises application of traverse machining driven tools.



MILLING OF TEETH

The TMZ machinery series offers technical prerequisites for implementation and installation of special equipment. That allows for manufacture of tothing for worm drive directly on the machine.

NEW

		TMZ867CNC	TMZ642CNC	TMZ625CNC
MAXIMUM MATERIAL DIAMETER	with automatic feeder	73 mm	48 mm	32 mm
	material guide	67 mm	42 mm	–
SPINDLE	quantity	8	6	6
	spindles pitch	480 mm	340 mm	300 mm
	max. spindle speed	2,500 min ⁻¹	5,000 min ⁻¹	6,000 min ⁻¹
	max. output/spindle (100/40 %)	20/30 kW	7/10.5 kW	7 kW
	min. idle period	1 s	1 s	0.8 s
LONGIDUTINAL SADDLES	quantity	8	6	6
	max. fast traverse	30 m/min	30 m/min	30 m/min
	traverse force	10,000 N	3,400 N	2,200 N
	stroke	340 mm	250 mm	250 mm
CROSS saddleS Z/X	quantity	7	5	5
	max. fast traverse	15 m/min	15 m/min	15 m/min
	axial stroke (Z)	120 mm	120 mm	120 mm
	axial traverse force (Z)	3,700 N	3,700 N	3,600 N
	radial stroke (X)	80 mm	80 mm	75 mm
	radial traverse force (X)	3,700 N	3,700 N	3,500 N
PICK-UP SADDLE	max. fast traverse	15 m/min	15 m/min	15 m/min
	traverse force	2,900 N	2,900 N	1,700 N
	stroke	70 mm	66 mm	80 mm
MACHINE DIMENSIONS	length (without material guide)	4,230 mm	3,696 mm	4,785 mm
	width	2,185 mm	1,914 mm	2,300 mm
	height	2,993 mm	2,746 mm	2,900 mm
	weight	17,000 kg	10,750 kg	10,500 kg
	coolant volume	1,400 l	1,250 l	1,000 l
ELECTRIC BOX DIMENSIONS	length × width × height	5,000 × 600 × 2,200 mm	3,400 × 600 × 2,435 mm	–
	weight	1,924 kg	1,000 kg	–

OPTIONS

Y- AXIS	in positions	2, 3, 4, 5, 6 or 7	2, 3, 4 or 5	2, 3, 4 or 5
	max. fast traverse	15 m/min	15 m/min	15 m/min
	traverse force	2,900 N	2,900 N	2,000 N
	stroke	110 mm	110 mm	110 mm
PARTS TAKER	max. speed	4,500 min ⁻¹	6,000 min ⁻¹	6,000 min ⁻¹
	max. torque	30 Nm	20 Nm	20 Nm
MACHINING ON PICK-UP SIDE X	max. fast traverse	15 m/min	15 m/min	30 m/min
	traverse force	2,900 N	2,900 N	2,500 N
	stroke	90 mm	75 mm	120 mm
MACHINING ON PICK-UP SIDE X/Y	max. fast traverse	15 m/min	15 m/min	15 m/min
	traverse force	2,900 N	2,900 N	3,500 N
	stroke (X)	75 mm	75 mm	80 mm
	stroke (Y)	106 mm	106 mm	106 mm

WE ARE LOOKING FORWARD TO DIRECT CONTACT WITH YOU

TAJMAC CZECH REPUBLIC

TAJMAC-ZPS, a. s.
Trida 3. kvetna 1180
CZ-76487 Zlin, Malenovice
www.tajmac-zps.cz
Czech Republic

TAJMAC FRANCE

MONEO
Le Grand Communal
Vougy 74130 Bonneville
www.moneo.fr
France

TAJMAC INDIA

A3; Saphire
16-A cross; 1st Main; Pai Layout
K.R.Puram; Bangalore 560016
www.tajmac-zps.cz
India

Wickman Machine Tools India Private Ltd.
#851, Aggundapalli Village, Kalamangala Road
Achattyapalli Post, Hosure – 635110
Tamil Nadu
www.wickman-group.com
India

TAJMAC ITALY

TAJMAC-MTM S.p.A.
Via Gran Sasso 15
IT-20092 Cinisello B. Mo (MI)
www.tajmac-mtm.it
Italy

TAJMAC USA

ZPS AMERICA LLC
4950 W. 79th Street
IN 46268 Indianapolis
www.zpsamerica.com
USA

TAJMAC BRASIL

WICKMAN BRASIL
Rua Dr. Alfonso Vergueiro
739 Vila Maria
Sao Paulo – SP CEP 02116-001
www.wickman-group.com
Brasil

TAJMAC GERMANY

TAJMAC-MSW GmbH
Robert Bosch Strasse 9
71299 Wimsheim
www.tajmac.msw.de
Germany

TAJMAC ENGLAND

WICKMAN COVENTRY LIMITED
Automatic House
Discovery Way
Leofric Business Park, Binley
www.wickman-group.com
England

